



a2zelectronic.com

Sourcing Simplified



Applications

- Switch Mode Power Supply (SMPS)
- Uninterruptable Power Supply
- High speed power switching

V_{DSS}	R_{ds(on)} max	I_D
500V	0.27Ω	20A

Benefits

- Low Gate Charge Q_g results in Simple Drive Requirement
- Improved Gate, Avalanche and dynamic dv/dt Ruggedness
- Fully Characterized Capacitance and Avalanche Voltage and Current
- Effective Coss specified (See AN1001)

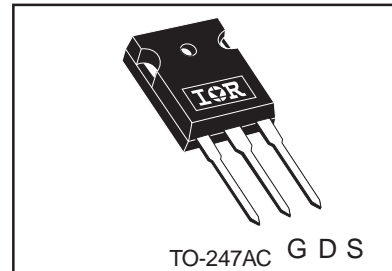

Absolute Maximum Ratings

	Parameter	Max.	Units
I _D @ T _C = 25°C	Continuous Drain Current, V _{GS} @ 10V	20	A
I _D @ T _C = 100°C	Continuous Drain Current, V _{GS} @ 10V	13	
I _{DM}	Pulsed Drain Current ①	80	
P _D @ T _C = 25°C	Power Dissipation	280	W
	Linear Derating Factor	2.2	W/°C
V _{GS}	Gate-to-Source Voltage	± 30	V
dv/dt	Peak Diode Recovery dv/dt ③	3.8	V/ns
T _J	Operating Junction and	-55 to + 150	°C
T _{STG}	Storage Temperature Range		
	Soldering Temperature, for 10 seconds	300 (1.6mm from case)	
	Mounting torque, 6-32 or M3 screw	10 lbf•in (1.1N•m)	

Typical SMPS Topologies:

- Full Bridge
- PFC Boost

Notes ① through ⑤ are on page 8
www.irf.com

IRFP460A

International
IR Rectifier

Static @ $T_J = 25^\circ\text{C}$ (unless otherwise specified)

	Parameter	Min.	Typ.	Max.	Units	Conditions
$V_{(BR)DSS}$	Drain-to-Source Breakdown Voltage	500	—	—	V	$V_{GS} = 0V, I_D = 250\mu A$
$\Delta V_{(BR)DSS}/\Delta T_J$	Breakdown Voltage Temp. Coefficient	—	0.61	—		$V/^\circ\text{C}$ Reference to $25^\circ\text{C}, I_D = 1\text{mA}$
$R_{DS(on)}$	Static Drain-to-Source On-Resistance	—	—	0.27	Ω	$V_{GS} = 10V, I_D = 12A$ ④
$V_{GS(th)}$	Gate Threshold Voltage	2.0	—	4.0	V	$V_{DS} = V_{GS}, I_D = 250\mu A$
I_{DSS}	Drain-to-Source Leakage Current	—	—	25 250	μA	$V_{DS} = 500V, V_{GS} = 0V$ $V_{DS} = 400V, V_{GS} = 0V, T_J = 125^\circ\text{C}$
I_{GSS}	Gate-to-Source Forward Leakage	—	—	100	nA	$V_{GS} = 30V$
	Gate-to-Source Reverse Leakage	—	—	-100		$V_{GS} = -30V$

Dynamic @ $T_J = 25^\circ\text{C}$ (unless otherwise specified)

	Parameter	Min.	Typ.	Max.	Units	Conditions
g_{fs}	Forward Transconductance	11	—	—	S	$V_{DS} = 50V, I_D = 12A$
Q_g	Total Gate Charge	—	—	105	nC	$I_D = 20A$ $V_{DS} = 400V$ $V_{GS} = 10V$, See Fig. 6 and 13 ④
Q_{gs}	Gate-to-Source Charge	—	—	26		
Q_{gd}	Gate-to-Drain ("Miller") Charge	—	—	42	ns	$V_{DD} = 250V$ $I_D = 20A$ $R_G = 4.3\Omega$ $R_D = 13\Omega$, See Fig. 10 ④
$t_{d(on)}$	Turn-On Delay Time	—	18	—		
t_r	Rise Time	—	55	—		
$t_{d(off)}$	Turn-Off Delay Time	—	45	—		
t_f	Fall Time	—	39	—		
C_{iss}	Input Capacitance	—	3100	—	pF	$V_{GS} = 0V$ $V_{DS} = 25V$ $f = 1.0\text{MHz}$, See Fig. 5
C_{oss}	Output Capacitance	—	480	—		
C_{rss}	Reverse Transfer Capacitance	—	18	—		
C_{oss}	Output Capacitance	—	4430	—		
C_{oss}	Output Capacitance	—	130	—		
$C_{oss \text{ eff.}}$	Effective Output Capacitance	—	140	—		

Avalanche Characteristics

	Parameter	Typ.	Max.	Units
E_{AS}	Single Pulse Avalanche Energy②	—	960	mJ
I_{AR}	Avalanche Current①	—	20	A
E_{AR}	Repetitive Avalanche Energy①	—	28	mJ

Thermal Resistance

	Parameter	Typ.	Max.	Units
$R_{\theta JC}$	Junction-to-Case	—	0.45	$^\circ\text{C}/\text{W}$
$R_{\theta CS}$	Case-to-Sink, Flat, Greased Surface	0.24	—	
$R_{\theta JA}$	Junction-to-Ambient	—	40	

Diode Characteristics

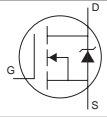
	Parameter	Min.	Typ.	Max.	Units	Conditions
I_S	Continuous Source Current (Body Diode)	—	—	20	A	MOSFET symbol showing the integral reverse p-n junction diode. 
I_{SM}	Pulsed Source Current (Body Diode) ①	—	—	80		
V_{SD}	Diode Forward Voltage	—	—	1.8	V	$T_J = 25^\circ\text{C}, I_S = 20A, V_{GS} = 0V$ ④
t_{rr}	Reverse Recovery Time	—	480	710	ns	$T_J = 25^\circ\text{C}, I_F = 20A$
Q_{rr}	Reverse Recovery Charge	—	5.0	7.5	μC	$di/dt = 100A/\mu\text{s}$ ④
t_{on}	Forward Turn-On Time	Intrinsic turn-on time is negligible (turn-on is dominated by L_S+L_D)				

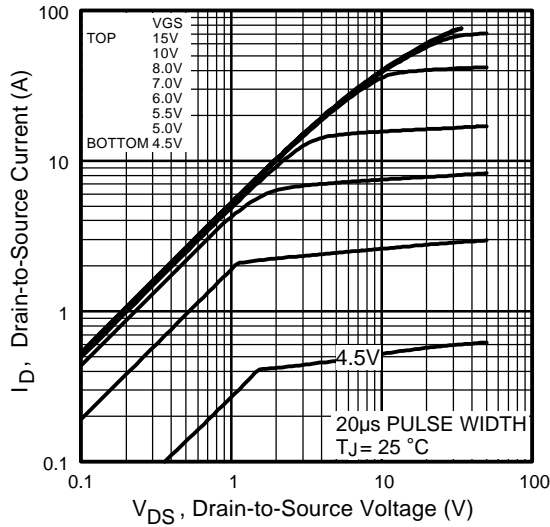

Fig 1. Typical Output Characteristics

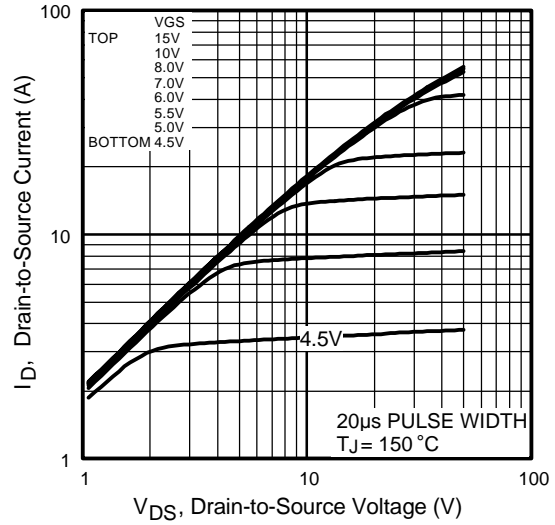

Fig 2. Typical Output Characteristics

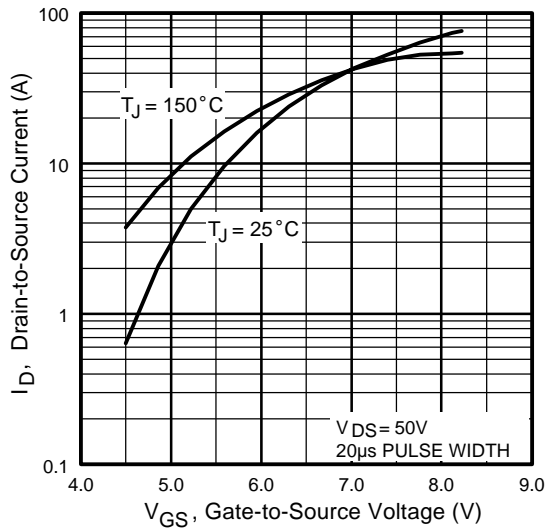

Fig 3. Typical Transfer Characteristics

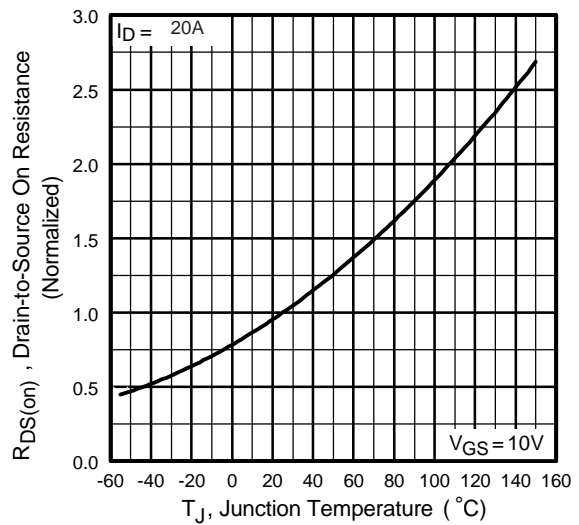

Fig 4. Normalized On-Resistance Vs. Temperature

IRFP460A

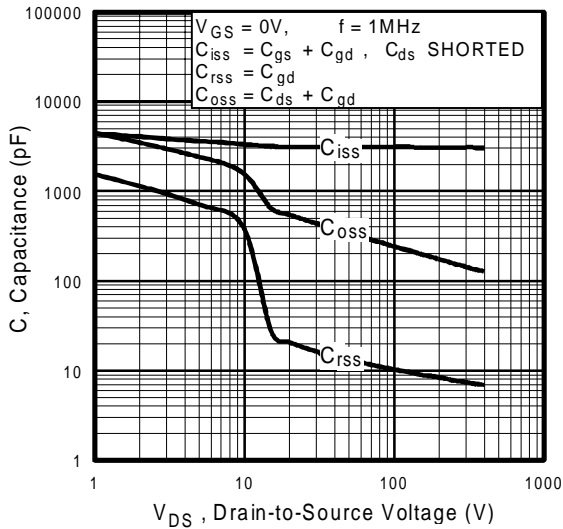

Fig 5. Typical Capacitance Vs. Drain-to-Source Voltage

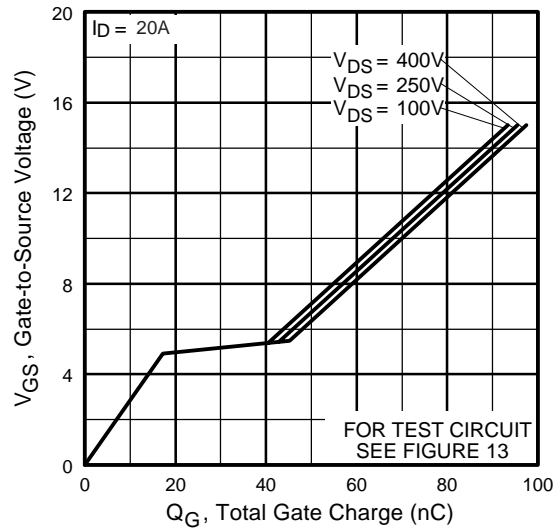

Fig 6. Typical Gate Charge Vs. Gate-to-Source Voltage

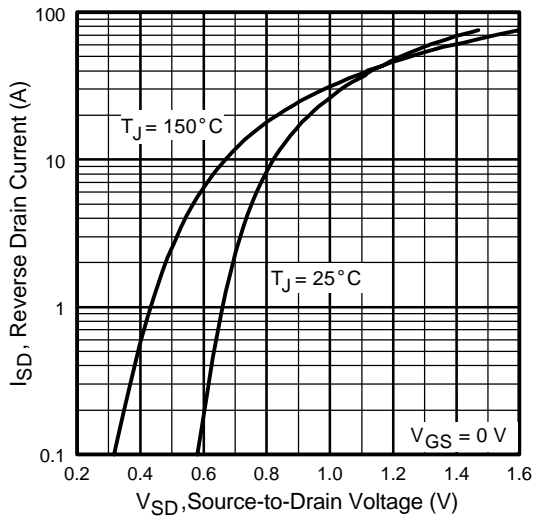

Fig 7. Typical Source-Drain Diode Forward Voltage

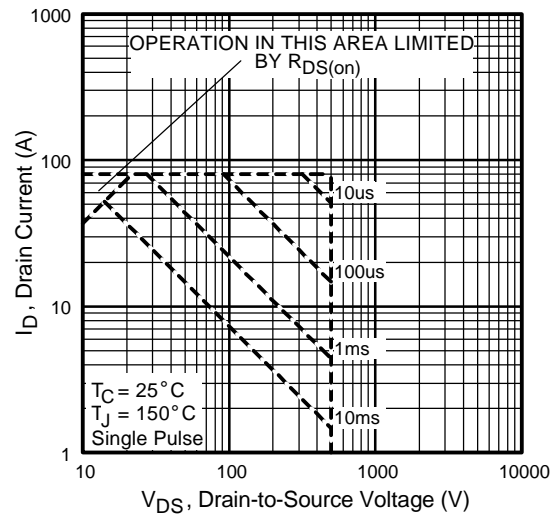

Fig 8. Maximum Safe Operating Area

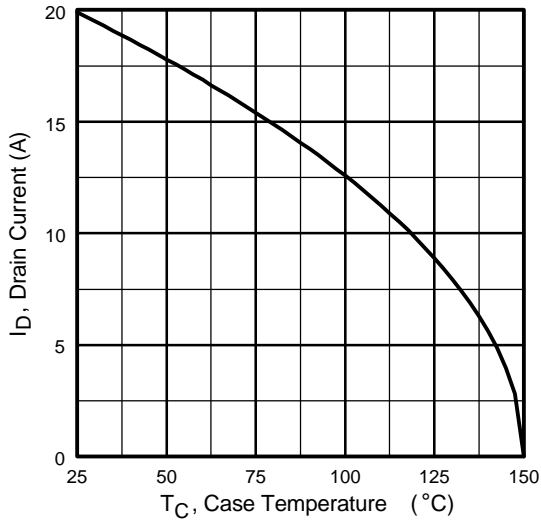

Fig 9. Maximum Drain Current Vs. Case Temperature

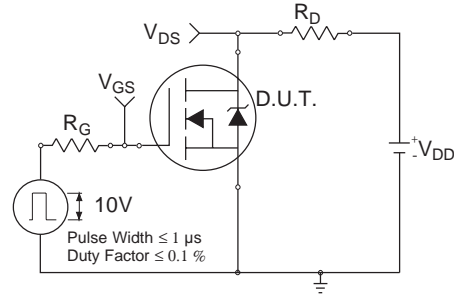

Fig 10a. Switching Time Test Circuit

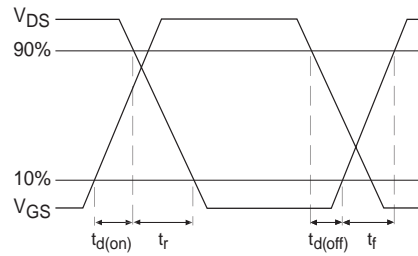

Fig 10b. Switching Time Waveforms

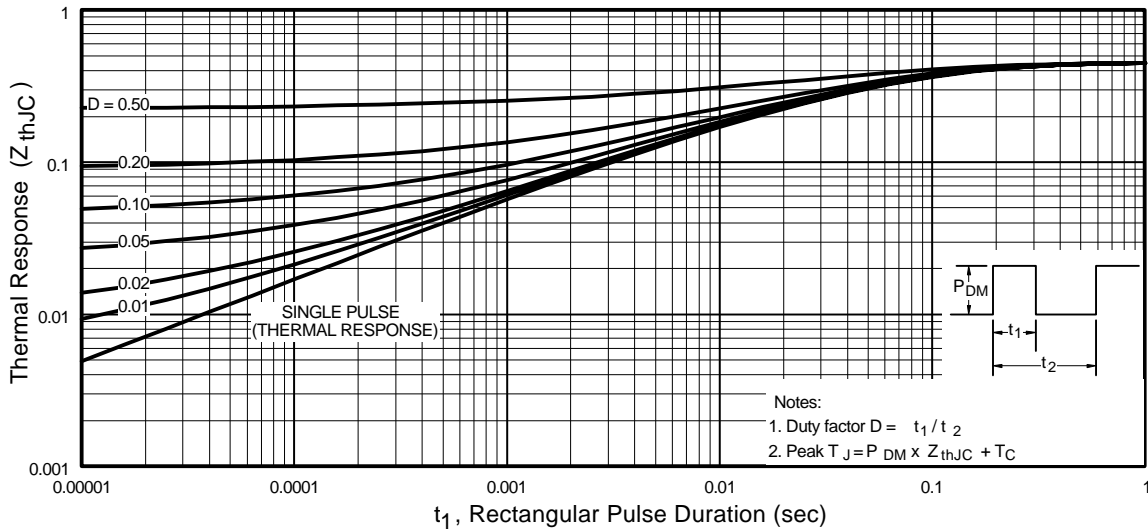

Fig 11. Maximum Effective Transient Thermal Impedance, Junction-to-Case

IRFP460A

International
IR Rectifier

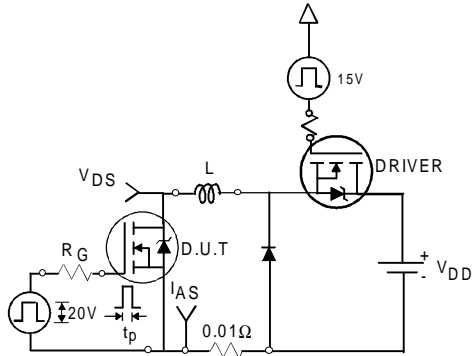

Fig 12a. Unclamped Inductive Test Circuit

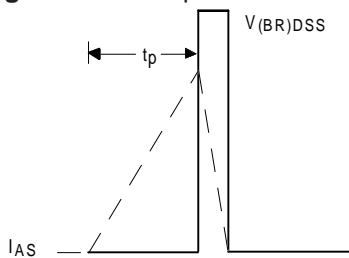

Fig 12b. Unclamped Inductive Waveforms

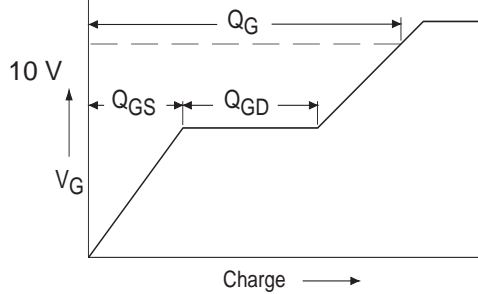

Fig 13a. Basic Gate Charge Waveform

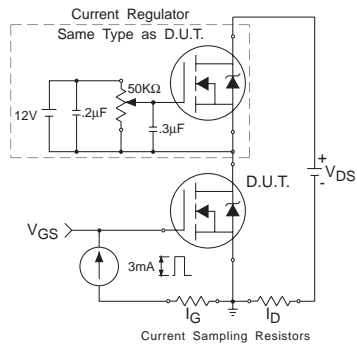

Fig 13b. Gate Charge Test Circuit

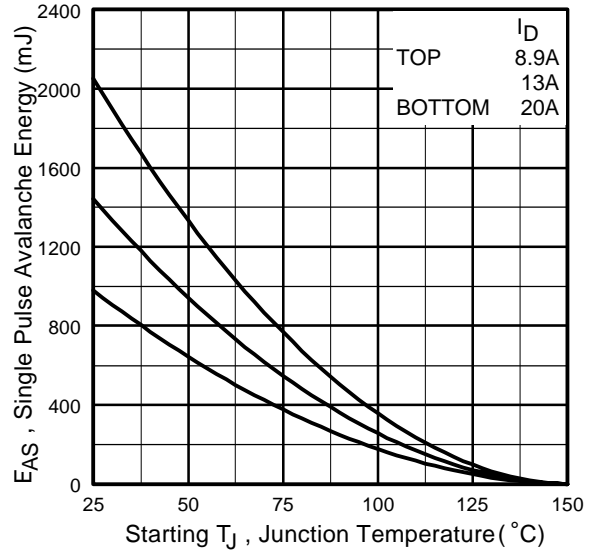

Fig 12c. Maximum Avalanche Energy Vs. Drain Current

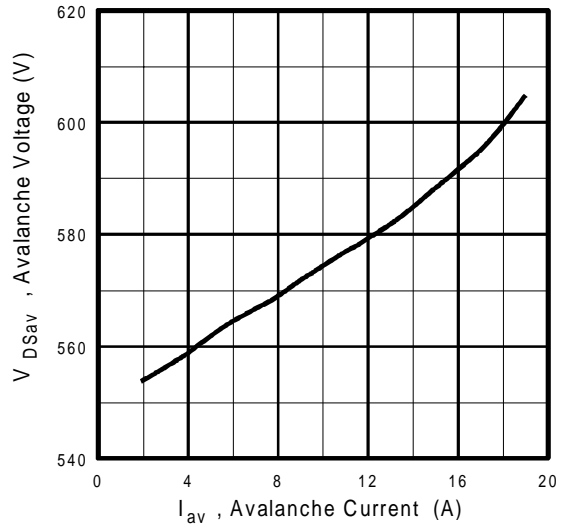
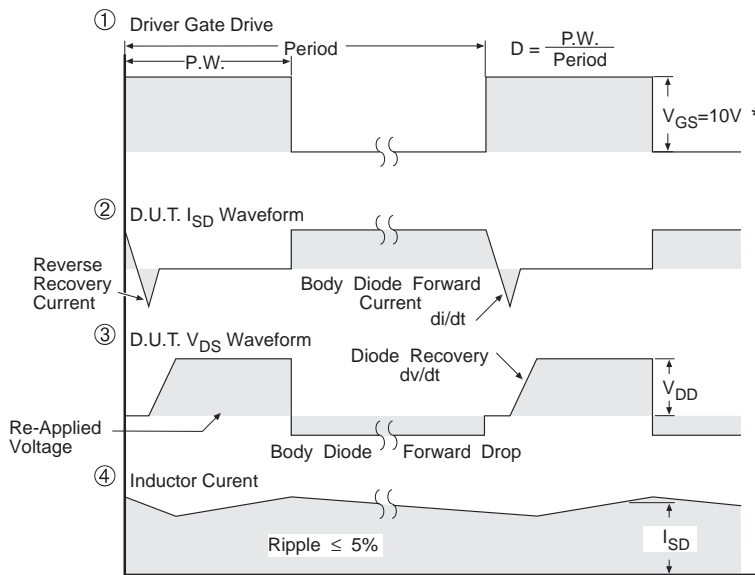
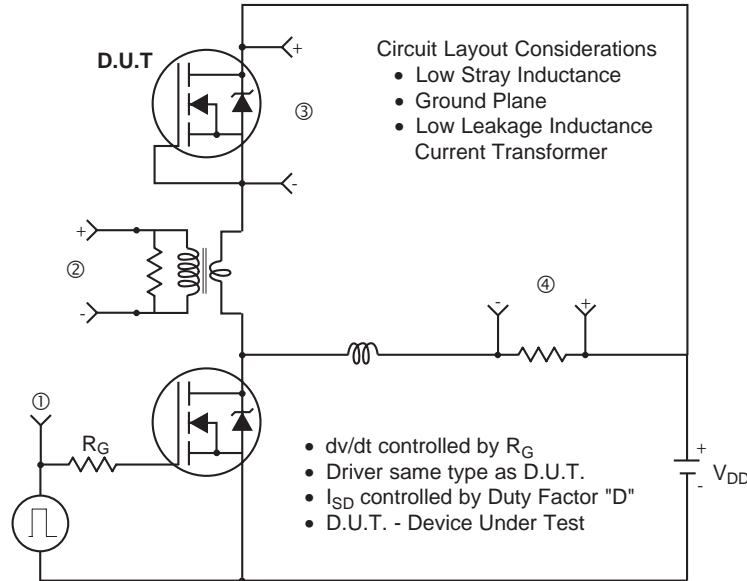

Fig 12d. Typical Drain-to-Source Voltage Vs. Avalanche Current

Peak Diode Recovery dv/dt Test Circuit



* $V_{GS} = 5V$ for Logic Level Devices

Fig 14. For N-Channel HEXFETS

IRFP460A

Package Outline

International
IR Rectifier

TO-247AC Outline

Dimensions are shown in millimeters (inches)

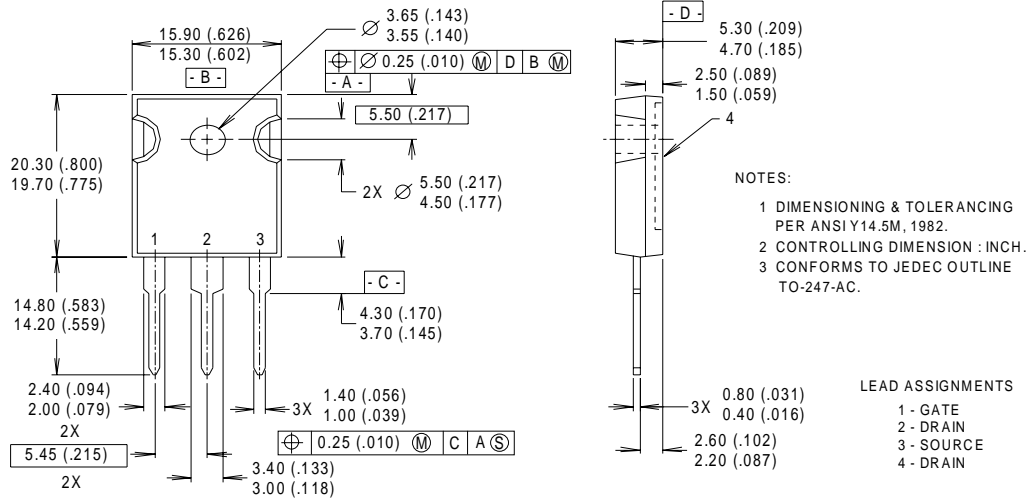

Part Marking Information

TO-247AC

EXAMPLE : THIS IS AN IRFPE30
WITH ASSEMBLY
LOT CODE 3A1Q

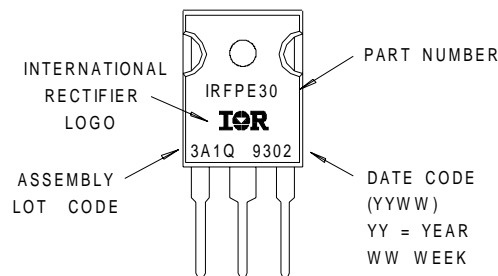

Notes:

- ① Repetitive rating; pulse width limited by max. junction temperature. (See fig. 11)
- ② Starting $T_J = 25^\circ\text{C}$, $L = 4.3\text{mH}$
 $R_G = 25\Omega$, $I_{AS} = 20\text{A}$. (See Figure 12)
- ③ $I_{SD} \leq 20\text{A}$, $di/dt \leq 125\text{A}/\mu\text{s}$, $V_{DD} \leq V_{(BR)DSS}$,
 $T_J \leq 150^\circ\text{C}$
- ④ Pulse width $\leq 300\mu\text{s}$; duty cycle $\leq 2\%$.
- ⑤ C_{OSS} eff. is a fixed capacitance that gives the same charging time as C_{OSS} while V_{DS} is rising from 0 to 80% V_{DSS}

International
IR Rectifier

WORLD HEADQUARTERS: 233 Kansas St., El Segundo, California 90245, Tel: (310) 322 3331

IR GREAT BRITAIN: Hurst Green, Oxted, Surrey RH8 9BB, UK Tel: ++ 44 1883 732020

IR CANADA: 15 Lincoln Court, Brampton, Ontario L6T3Z2, Tel: (905) 453 2200

IR GERMANY: Saalburgstrasse 157, 61350 Bad Homburg Tel: ++ 49 6172 96590

IR ITALY: Via Liguria 49, 10071 Borgaro, Torino Tel: ++ 39 11 451 0111

IR FAR EAST: K&H Bldg., 2F, 30-4 Nishi-Ikebukuro 3-Chome, Toshima-Ku, Tokyo Japan 171 Tel: 81 3 3983 0086

IR SOUTHEAST ASIA: 1 Kim Seng Promenade, Great World City West Tower, 13-11, Singapore 237994 Tel: ++ 65 838 4630

IR TAIWAN: 16 Fl. Suite D. 207, Sec. 2, Tun Haw South Road, Taipei, 10673, Taiwan Tel: 886-2-2377-9936

<http://www.irf.com/> Data and specifications subject to change without notice. 6/99