

buy electronic components online now.....@

a2zelectronic.com

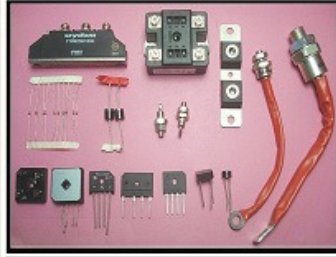

Capacitors



Diodes

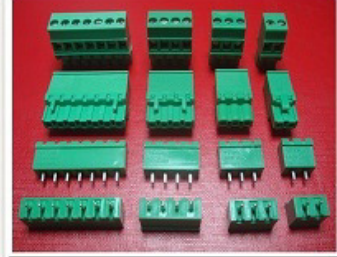

**Terminal Blocks
PCB Mountable**



Transistors



LCD Displays



Instrument Cooling Fan

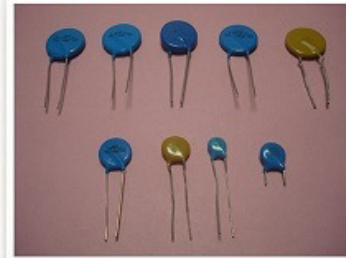

**MOV's
Metal Oxide Variators**



IC's



Fuses

All Industrial Electronic components Available.

**Capacitors (D.C. & A/C)
IGBTs
MOSFETs
Semiconductors
SCRs
Switches**

**Relays
Connectors
Terminal Blocks
LCD's
Resistors
Transistors, Buzzers**

**7 Seg LED Displays
Instrument cooling Fans
Fuse & Fuse Holder
MOV's, Heat Sinks, Diodes
IC's, Knob's, Trim pots,
LED Power Supply...etc.,**

2MBI150VB-120-50

IGBT Modules

IGBT MODULE (V series) 1200V / 150A / 2 in one package

■ Features

- High speed switching
- Voltage drive
- Low Inductance module structure

■ Applications

- Inverter for Motor Drive
- AC and DC Servo Drive Amplifier
- Uninterruptible Power Supply
- Industrial machines, such as Welding machines



■ Maximum Ratings and Characteristics

● Absolute Maximum Ratings (at $T_c=25^\circ\text{C}$ unless otherwise specified)

Items	Symbols	Conditions	Maximum ratings	Units
Collector-Emitter voltage	V_{CES}		1200	V
Gate-Emitter voltage	V_{GES}		± 20	V
Collector current	I_C	Continuous $T_c=100^\circ\text{C}$	150	
	$I_{C\ pulse}$	1ms	300	
	$-I_C$		150	
	$-I_{C\ pulse}$	1ms	300	
Collector power dissipation	P_C	1 device	1070	W
Junction temperature	T_J		175	$^\circ\text{C}$
Operating junction temperature (under switching conditions)	T_{Jop}		150	
Case temperature	T_C		125	
Storage temperature	T_{stg}		$-40 \sim 125$	
Isolation voltage	between terminal and copper base (*1) V_{iso}	AC : 1min.	2500	VAC
Screw torque	Mounting (*2)		3.5	N m
	Terminals (*3)		3.5	

Note *1: All terminals should be connected together during the test.

Note *2: Recommendable Value : 2.5-3.5 Nm (M5 or M6)

Note *3: Recommendable Value : 2.5-3.5 Nm (M5)

● Electrical characteristics (at $T_J=25^\circ\text{C}$ unless otherwise specified)

Items	Symbols	Conditions	Characteristics			Units	
			min.	typ.	max.		
Zero gate voltage collector current	I_{CES}	$V_{GE} = 0V, V_{CE} = 1200V$	-	-	2.0	mA	
Gate-Emitter leakage current	I_{GES}	$V_{CE} = 0V, V_{GE} = \pm 20V$	-	-	400	nA	
Gate-Emitter threshold voltage	$V_{GE(th)}$	$V_{CE} = 20V, I_C = 150mA$	6.0	6.5	7.0	V	
Collector-Emitter saturation voltage	$V_{CE(sat)}(terminal)$	$V_{GE} = 15V$ $I_C = 150A$	$T_J=25^\circ\text{C}$	-	2.00	2.45	V
			$T_J=125^\circ\text{C}$	-	2.35	-	
			$T_J=150^\circ\text{C}$	-	2.40	-	
	$V_{CE(sat)}(chip)$	$V_{GE} = 15V$ $I_C = 150A$	$T_J=25^\circ\text{C}$	-	1.85	2.30	
			$T_J=125^\circ\text{C}$	-	2.20	-	
			$T_J=150^\circ\text{C}$	-	2.25	-	
Internal gate resistance	$R_{G(int)}$	-	-	5.0	-	Ω	
Input capacitance	C_{ies}	$V_{CE} = 10V, V_{GE} = 0V, f = 1MHz$	-	12.0	-	nF	
Turn-on time	t_{on}	$V_{CC} = 600V, L_S = 30nH$	-	600	-	nsec	
	t_r	$I_C = 150A$	-	200	-		
	$t_{(i)}$	$V_{GE} = \pm 15V$	-	50	-		
Turn-off time	t_{off}	$R_G = 4.2\Omega$	-	800	-	nsec	
	t_r	$T_J = 150^\circ\text{C}$	-	80	-		
			-	80	-		
Forward on voltage	$V_F(terminal)$	$V_{GE} = 0V$ $I_F = 150A$	$T_J=25^\circ\text{C}$	-	1.85	2.30	V
			$T_J=125^\circ\text{C}$	-	2.00	-	
			$T_J=150^\circ\text{C}$	-	1.95	-	
	$V_F(chip)$	$V_{GE} = 0V$ $I_F = 150A$	$T_J=25^\circ\text{C}$	-	1.70	2.15	
			$T_J=125^\circ\text{C}$	-	1.85	-	
			$T_J=150^\circ\text{C}$	-	1.80	-	
Reverse recovery time	t_{rr}	$I_F = 150A$	-	150	-	nsec	

● Thermal resistance characteristics

Items	Symbols	Conditions	Characteristics			Units
			min.	typ.	max.	
Thermal resistance (1device)	$R_{th(j-c)}$	IGBT	-	-	0.140	$^\circ\text{C/W}$
		FWD	-	-	0.200	
Contact thermal resistance (1device) (*4)	$R_{th(c-f)}$	with Thermal Compound	-	0.025	-	

Note *4: This is the value which is defined mounting on the additional cooling fin with thermal compound.

■ Characteristics (Representative)

Collector current vs. Collector-Emittter voltage (typ.)
 $T_j = 25^\circ\text{C}$ / chip

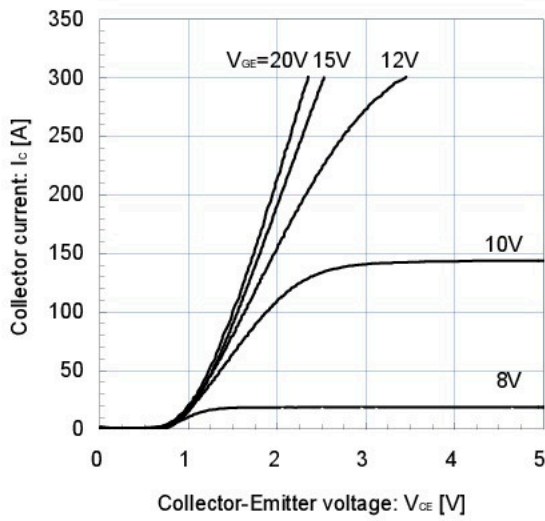

Collector current vs. Collector-Emittter voltage (typ.)
 $T_j = 150^\circ\text{C}$ / chip

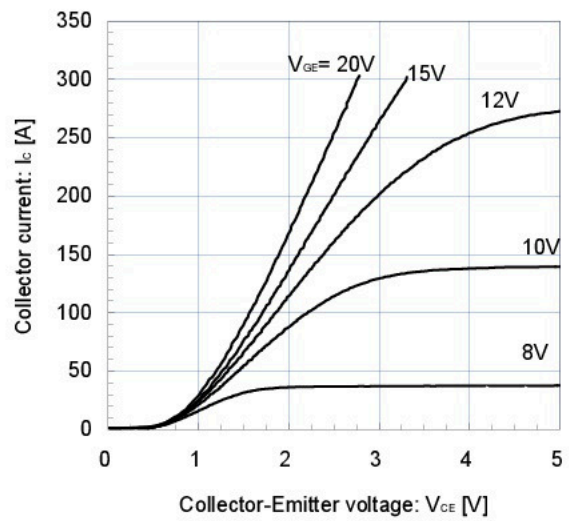

Collector current vs. Collector-Emittter voltage (typ.)
 $V_{ge} = 15\text{V}$ / chip

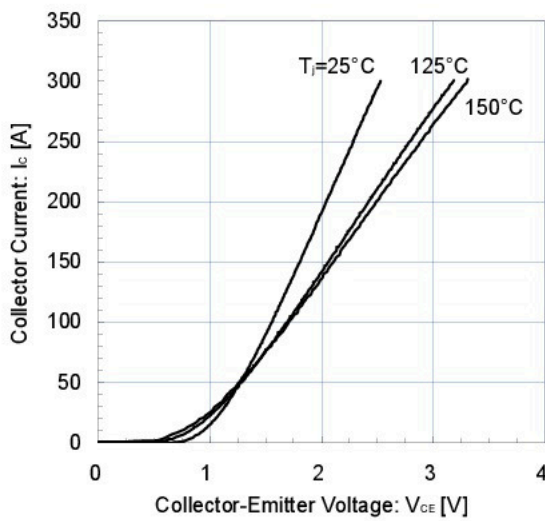

Collector-Emittter voltage vs. Gate-Emittter voltage
 $T_j = 25^\circ\text{C}$ / chip

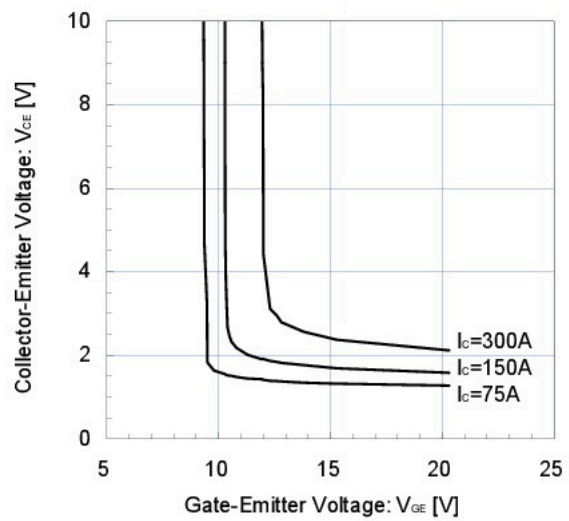

Gate Capacitance vs. Collector-Emittter Voltage
 $V_{ge} = 0\text{V}$, $f = 1\text{MHz}$, $T_j = 25^\circ\text{C}$

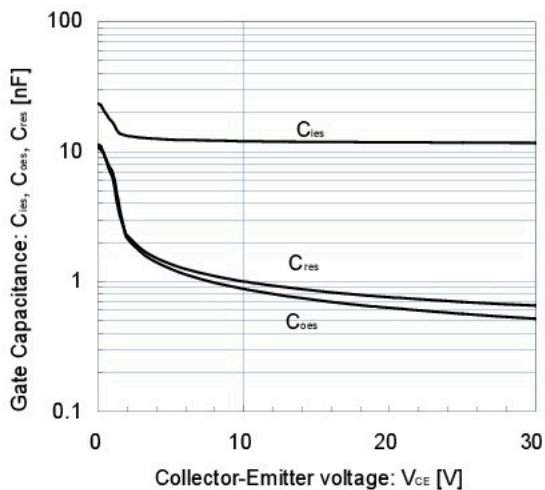

Dynamic Gate Charge (typ.)
 $V_{cc} = 600\text{V}$, $I_c = 150\text{A}$, $T_j = 25^\circ\text{C}$

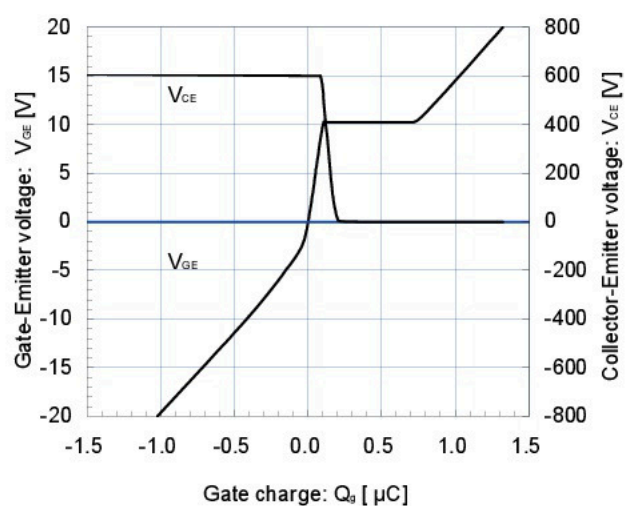

Switching time vs. Collector current (typ.)
 $V_{CC}=600V, V_{GE}=\pm 15V, R_G=4.2\Omega, T_J=125^\circ C$

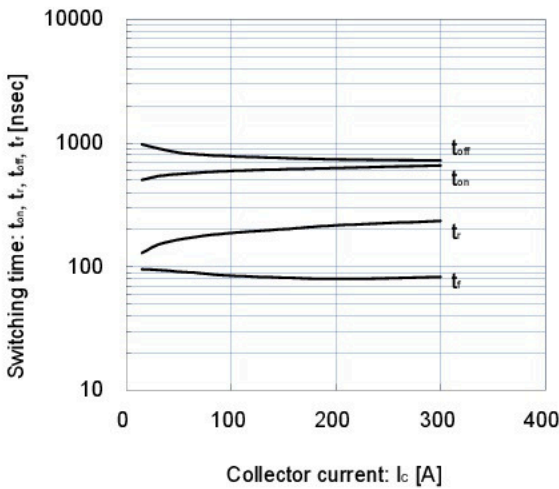

Switching time vs. Collector current (typ.)
 $V_{CC}=600V, V_{GE}=\pm 15V, R_G=4.2\Omega, T_J=150^\circ C$

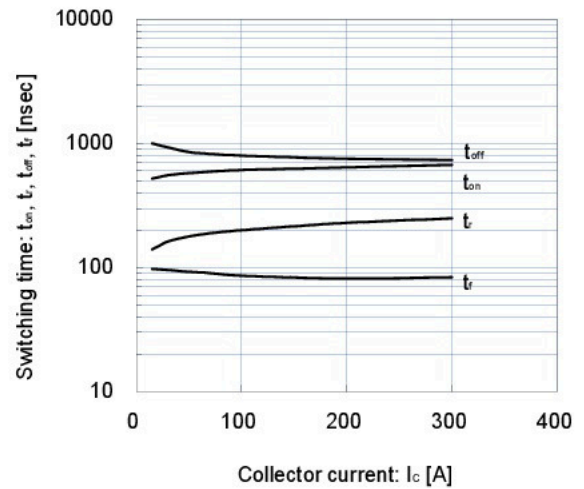

Switching time vs. Gate resistance (typ.)
 $V_{CC}=600V, I_c=150A, V_{GE}=\pm 15V, T_J=125^\circ C$

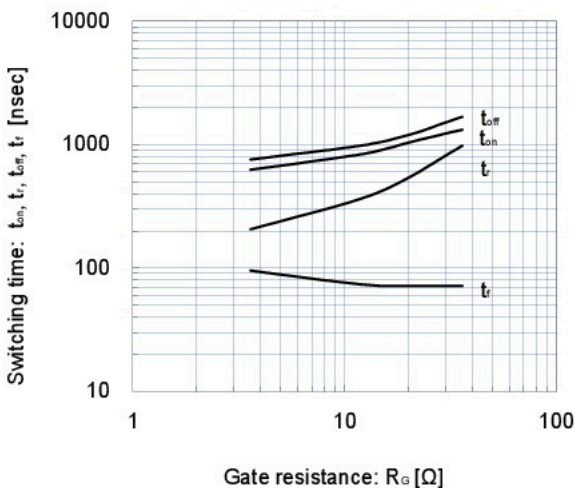

Switching loss vs. Collector current (typ.)
 $V_{CC}=600, V_{GE}=\pm 15V, R_G=4.2\Omega, T_J=125, 150^\circ C$

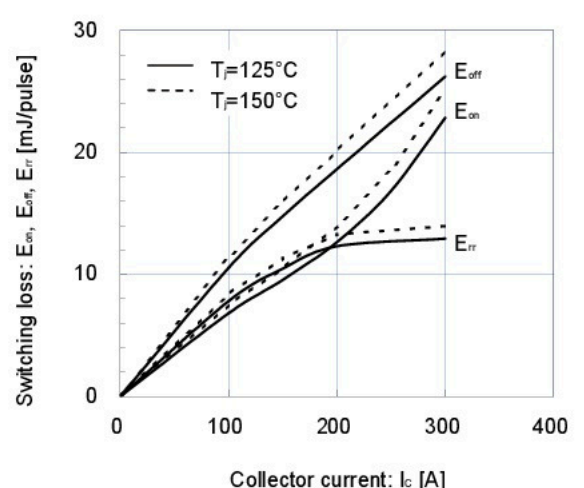

Switching loss vs. Gate resistance (typ.)
 $V_{CC}=600V, I_c=150A, V_{GE}=\pm 15V, T_J=125, 150^\circ C$

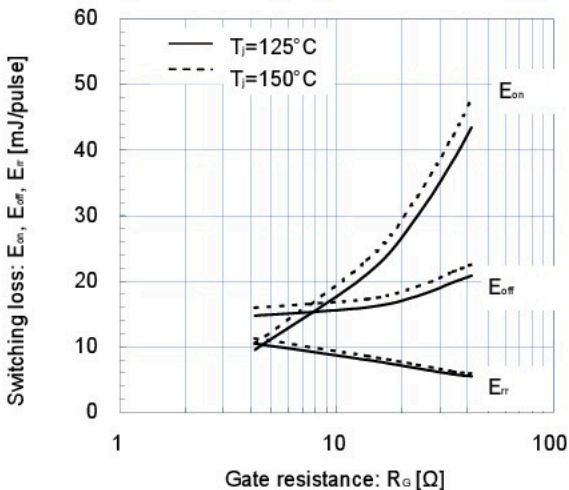

Reverse bias safe operating area (max.)
 $+V_{GE}=15V, -V_{GE}=15V, R_G=4.2\Omega, T_J=150^\circ C$

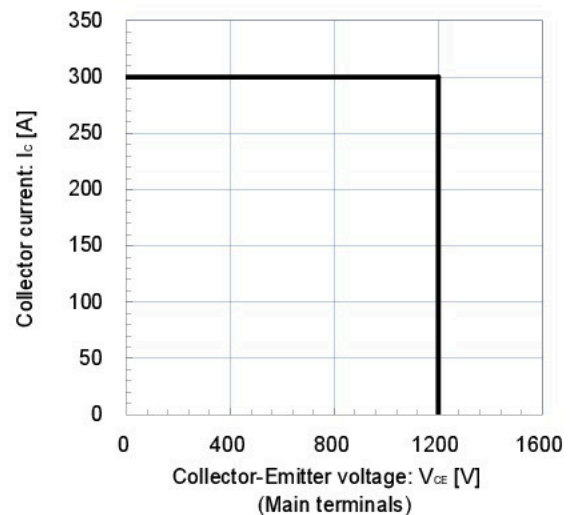

Forward Current vs. Forward Voltage (typ.)
chip

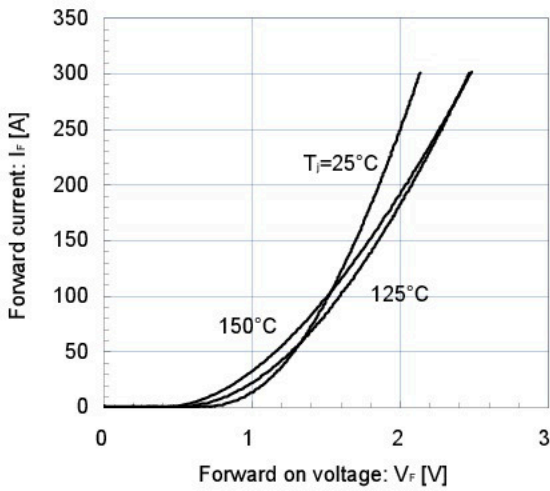

Reverse Recovery Characteristics (typ.)
 $V_{CC}=600V, V_{GE}=\pm 15V, R_G=4.2\Omega, T_j=125^\circ C$

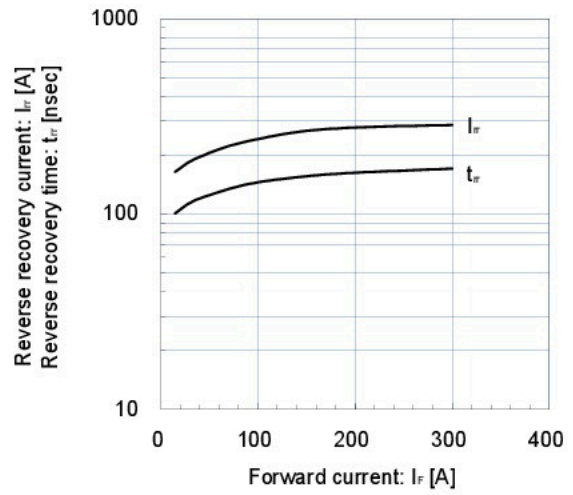

Reverse Recovery Characteristics (typ.)
 $V_{CC}=600V, V_{GE}=\pm 15V, R_G=4.2\Omega, T_j=150^\circ C$

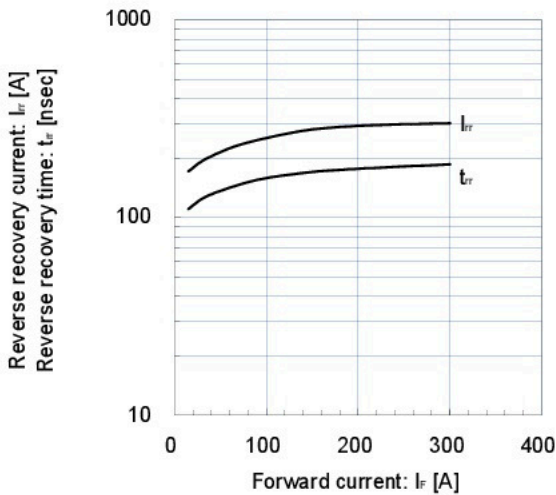

Transient Thermal Resistance (max.)

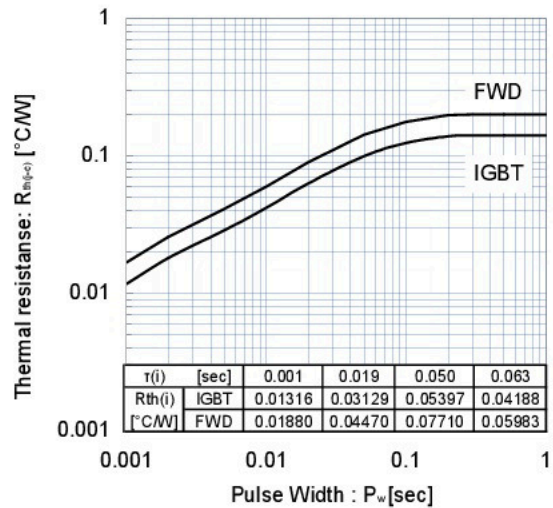

FWD safe operating area (max.)
 $T_j=150^\circ C$

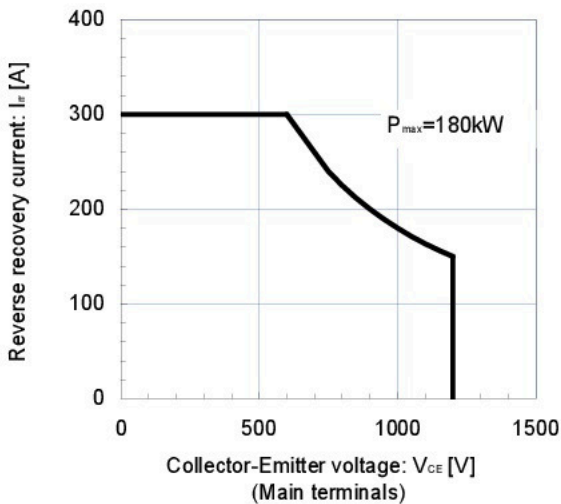

■ Outline Drawings, mm

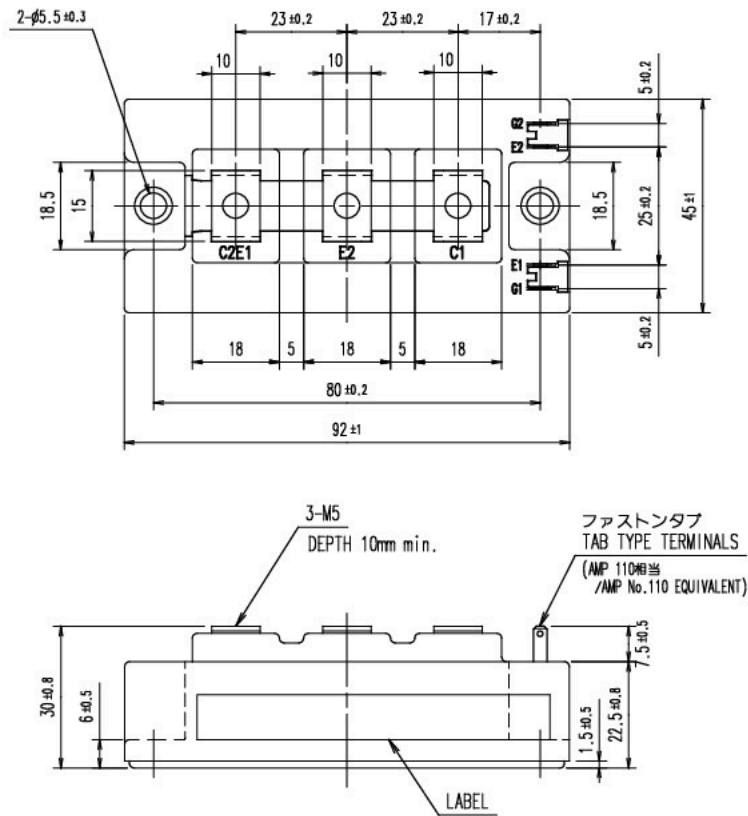

Weight: 270g (typ.)

■ Equivalent Circuit Schematic

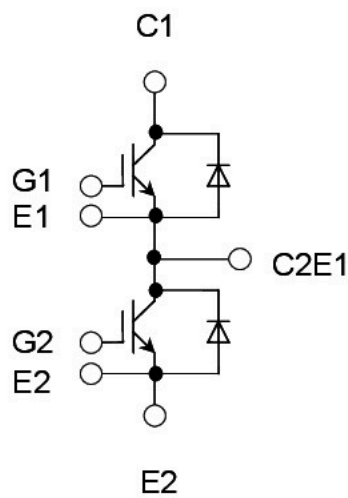

WARNING

1. This Catalog contains the product specifications, characteristics, data, materials, and structures as of July 2015. The contents are subject to change without notice for specification changes or other reasons. When using a product listed in this Catalog, be sure to obtain the latest specifications.
2. All applications described in this Catalog exemplify the use of Fuji's products for your reference only. No right or license, either express or implied, under any patent, copyright, trade secret or other intellectual property right owned by Fuji Electric Co., Ltd. is (or shall be deemed) granted. Fuji Electric Co., Ltd. makes no representation or warranty, whether express or implied, relating to the infringement or alleged infringement of other's intellectual property rights which may arise from the use of the applications described herein.
3. Although Fuji Electric Co., Ltd. is enhancing product quality and reliability, a small percentage of semiconductor products may become faulty. When using Fuji Electric semiconductor products in your equipment, you are requested to take adequate safety measures to prevent the equipment from causing a physical injury, fire, or other problem if any of the products become faulty. It is recommended to make your design failsafe, flame retardant, and free of malfunction.
4. The products introduced in this Catalog are intended for use in the following electronic and electrical equipment which has normal reliability requirements.

• Computers	• OA equipment	• Communications equipment (terminal devices)	• Measurement equipment
• Machine tools	• Audiovisual equipment	• Electrical home appliances	• Personal equipment
			• Industrial robots etc.
5. If you need to use a product in this Catalog for equipment requiring higher reliability than normal, such as for the equipment listed below, it is imperative to contact Fuji Electric Co., Ltd. to obtain prior approval. When using these products for such equipment, take adequate measures such as a backup system to prevent the equipment from malfunctioning even if a Fuji's product incorporated in the equipment becomes faulty.

• Transportation equipment (mounted on cars and ships)	• Trunk communications equipment
• Traffic-signal control equipment	• Gas leakage detectors with an auto-shut-off feature
• Emergency equipment for responding to disasters and anti-burglary devices	• Safety devices
• Medical equipment	
6. Do not use products in this Catalog for the equipment requiring strict reliability such as the following and equivalents to strategic equipment (without limitation).

• Space equipment	• Aeronautic equipment	• Nuclear control equipment
• Submarine repeater equipment		
7. Copyright ©1996-2015 by Fuji Electric Co., Ltd. All rights reserved.
No part of this Catalog may be reproduced in any form or by any means without the express permission of Fuji Electric Co., Ltd.
8. If you have any question about any portion in this Catalog, ask Fuji Electric Co., Ltd. or its sales agents before using the product. Neither Fuji Electric Co., Ltd. nor its agents shall be liable for any injury caused by any use of the products not in accordance with instructions set forth herein.



JAPAN

2MBI150VB-120-50

150A 1200V 30003



0016FAA000000000