



a2zelectronic.com

Sourcing Simplified



# KT-954

## GENERAL PURPOSE POWER RELAY

**KYOTA**

**RU** <sub>us</sub> E331430  
29.5×13×20.6

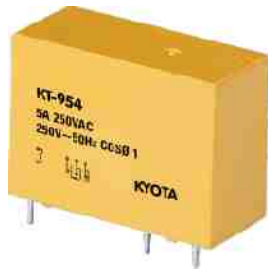

- 10A switching capability
- SPST-NO&SPDT configuration
- Small footprint
- Sealed version available
- Transparent sealed available
- Class B/F available
- Conform to RoHS,ELV directive

### CONTACT DATA

Contact Form	1A/1C
Contact Material	Silver Alloy
Load	Resistive load(COS Φ=1)
Contact Ratings	10A 240V AC 10 A 30 V DC
Minimum load	100mA 5VDC
Max Switching Voltage	250VAC/30VDC
Max Switching Current	12A
Max Switching Power	2500VA/300W
Contact Resistance	100m Ω Max at 6VDC 1A
Electrical	100, 000 Operations(at30 Operations/minute)
Mechanical	10, 000, 000 Operations(at300 Operations/minute)

### CHARACTERISTICS DATA

Insulation Resistance	100M Ω Min at 500VDC
Between Open Contacts	1000VAC(for one minute)
Between Contacts and Coil	5000VAC(for one minute)
Operate Time	20ms
Release Time	10ms
Temperature Range	-40℃to+70℃
Shock Resistance	Operating Extremes: 10G
	Damage Limits: 100G
Vibration Resistance	10-55Hz, 1.5mm
Max. switching frequency	Mechanical:18,000operations/hr
	Electrical:1,800operations/hr
Humidity	40-85%
Weight	Approx 14g

### COIL DATA

at 20℃

Coil Power 0.54W

Nominal Voltage (VDC)	Rated Current (mA)	Max Operate Voltage (VDC)	Min Release Voltage (VDC)	Coil Resistance (Ω ±10%)
3	180	2.4	0.15	17
5	108	4	0.25	46
6	90	4.8	0.3	67
9	60	7.2	0.45	150
12	45	9.6	0.6	270
24	22.5	19.2	1.2	1050
48	11.3	38.4	2.4	4250

Coil Power 0.72W

Nominal Voltage (VDC)	Rated Current (mA)	Max Operate Voltage (VDC)	Min Release Voltage (VDC)	Coil Resistance (Ω ±10%)
3	240	2.4	0.15	13
5	144	4	0.25	35
6	120	4.8	0.3	50
9	80	7.2	0.45	110
12	60	9.6	0.6	200
24	30	19.2	1.2	800
48	15	38.4	2.4	3200

### APPROVED STANDARDS

UL & cUL	10A 240V AC 10 A 30 V D C
----------	------------------------------

## OUTLINE DIMENSIONS, WIRING DIAGRAM AND LAYOUT

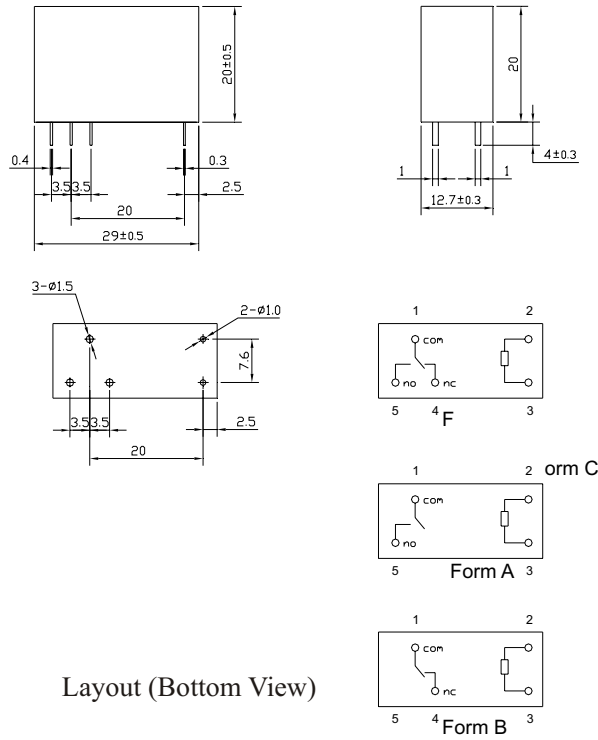

Layout (Bottom View)

## ENGINEERING DATA

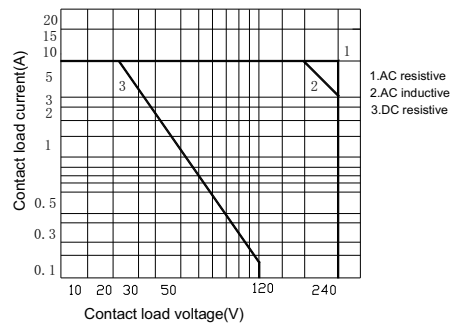
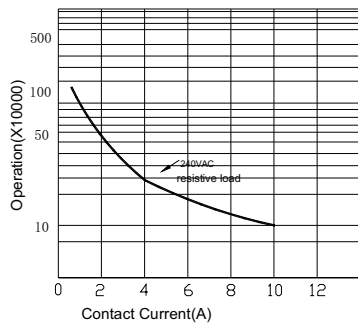
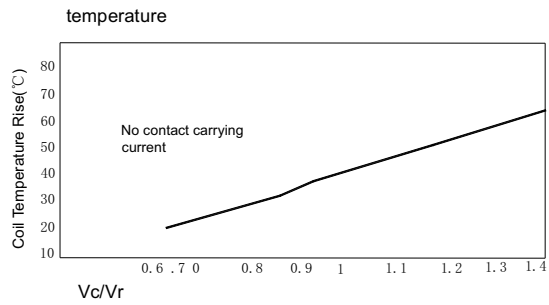
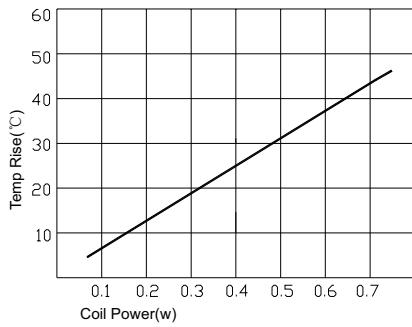

# KT-954

## GENERAL PURPOSE POWER RELAY

**KYOTA**

 **us** E331430  
29.5 × 13 × 20.6

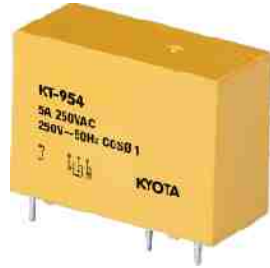

- 16A switching capability
- SPST-NO&SPDT configuration
- 5KV dielectric strength between coil and contacts
- Transparent sealed available
- Class B/F available
- Conform to RoHS,ELV directive

### CONTACT DATA

Contact Form	1AK / 1CK
Contact Material	Silver Alloy
Load	Resistive load(COS Φ=1)
Contact Ratings	16A 240V AC 16 A 3 0 V D C
Minimum load	100mA 5VDC
Max Switching Voltage	250VAC/30VDC
Max Switching Current	20A
Max Switching Power	4800VA/480W
Contact Resistance	100m Ω Max at 6VDC 1A
Electrical	100, 000 Operations(at30 Operations/minute)
Mechanical	10, 000, 000 Operations(at300 Operations/minute)

### CHARACTERISTICS DATA

Insulation Resistance	100M Ω Min at 500VDC
Between Open Contacts	1000VAC(for one minute)
Between Contacts and Coil	5000VAC(for one minute)
Operate Time	20ms
Release Time	10ms
Temperature Range	-40°C to +70°C
Shock Resistance	Operating Extremes: 10G
	Damage Limits: 100G
Vibration Resistance	10-55Hz, 1.5mm
Max. switching frequency	Mechanical: 18,000operations/hr Electrical: 1,800operations/hr
Humidity	40-85%
Weight	Approx 14g

### APPROVED STANDARDS

UL & cUL	16A 240VAC 16A 30 VDC
----------	--------------------------

### COIL DATA

at 20°C

Coil Power 0.24W

Nominal Voltage (VDC)	Rated Current (mA)	Max Operate Voltage (VDC)	Min Release Voltage (VDC)	Coil Resistance (Ω ± 10%)
3	80	2.4	0.15	38
5	48	4	0.25	104
6	40	4.8	0.3	150
9	26.7	7.2	0.45	338
12	20	9.6	0.6	600
24	10	19.2	1.2	2400
48	5	38.4	2.4	9600

Coil Power 0.54W

Nominal Voltage (VDC)	Rated Current (mA)	Max Operate Voltage (VDC)	Min Release Voltage (VDC)	Coil Resistance (Ω ± 10%)
3	180	2.4	0.15	17
5	108	4	0.25	46
6	90	4.8	0.3	67
9	60	7.2	0.45	150
12	45	9.6	0.6	270
24	22.5	19.2	1.2	1050
48	11.3	38.4	2.4	4250

Coil Power 0.72W

Nominal Voltage (VDC)	Rated Current (mA)	Max Operate Voltage (VDC)	Min Release Voltage (VDC)	Coil Resistance (Ω ± 10%)
3	240	2.4	0.15	13
5	144	4	0.25	35
6	120	4.8	0.3	50
9	80	7.2	0.45	110
12	60	9.6	0.6	200
24	30	19.2	1.2	800
48	15	38.4	2.4	3200

## OUTLINE DIMENSIONS, WIRING DIAGRAM AND LAYOUT

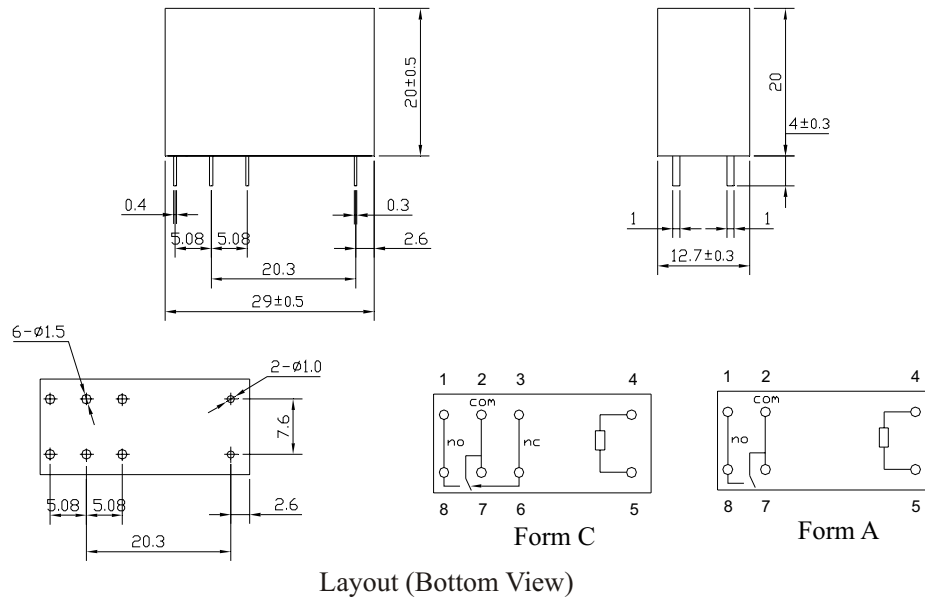

## ENGINEERING DATA

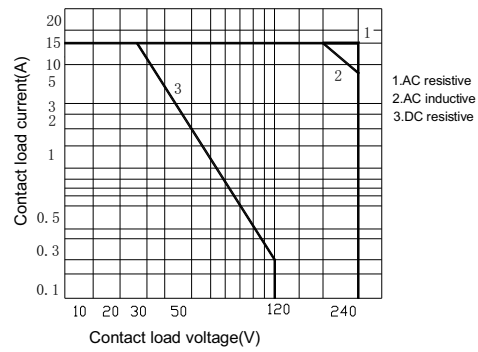
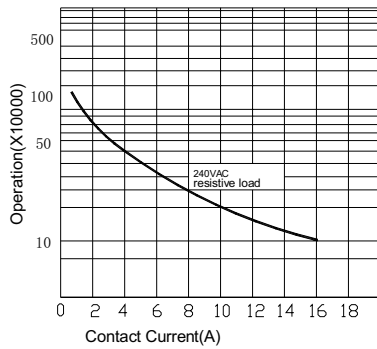
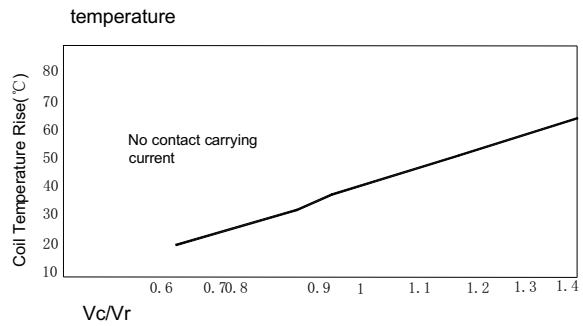
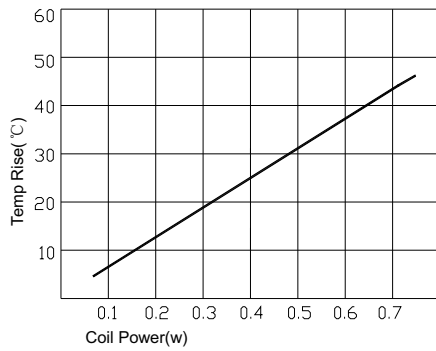

# KT-954

## GENERAL PURPOSE POWER RELAY

**KYOTA**

 **us E331430**  
29.5×13×20.6

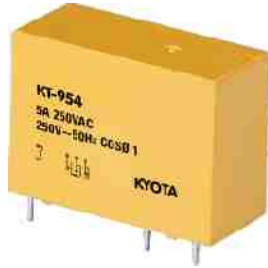

- Creepage distance:8.0mm Min
- Au-clad contact available
- Transparent sealed available
- Class B/F available
- Conform to RoHS,ELV directive

### CONTACT DATA

Contact Form	2A/2C
Contact Material	Silver Alloy
Load	Resistive load(COS Φ=1)
Contact Ratings	5A 240V AC 5A 3 0 V D C
Minimum load	100mA 5VDC
Max Switching Voltage	250VAC/30VDC
Max Switching Current	8A
Max Switching Power	1250VA/240W
Contact Resistance	100m Ω Max at 6VDC 1A
Electrical	100, 000 Operations(at30Operations/minute)
Mechanical	10, 000, 000 Operations(at300Operations/minute)

### CHARACTERISTICS DATA

Insulation Resistance	100M Ω Min at 500VDC
Between Open Contacts	1000VAC(for one minute)
Between Contacts and Coil	5000VAC(for one minute)
Operate Time	20ms
Release Time	10ms
Temperature Range	-40°C to +70°C
Shock Resistance	Operating Extremes: 10G
	Damage Limits: 100G
Vibration Resistance	10-55Hz, 1.5mm
Max. switching frequency	Mechanical:18,000operations/hr Electrical:1,800operations/hr
Humidity	40-85%
Weight	Approx 14g

### APPROVED STANDARDS

UL & cUL	5A 240VAC 5A 30VDC
----------	-----------------------

### COIL DATA

at 20°C

Coil Power 0.24W

Nominal Voltage (VDC)	Rated Current (mA)	Max Operate Voltage (VDC)	Min Release Voltage (VDC)	Coil Resistance (Ω ± 10%)
3	80	2.4	0.15	38
5	48	4	0.25	104
6	40	4.8	0.3	150
9	26.7	7.2	0.45	338
12	20	9.6	0.6	600
24	10	19.2	1.2	2400
48	5	38.4	2.4	9600

Coil Power 0.54W

Nominal Voltage (VDC)	Rated Current (mA)	Max Operate Voltage (VDC)	Min Release Voltage (VDC)	Coil Resistance (Ω ± 10%)
3	180	2.4	0.15	17
5	108	4	0.25	46
6	90	4.8	0.3	67
9	60	7.2	0.45	150
12	45	9.6	0.6	270
24	22.5	19.2	1.2	1050
48	11.3	38.4	2.4	4250

Coil Power 0.72W

Nominal Voltage (VDC)	Rated Current (mA)	Max Operate Voltage (VDC)	Min Release Voltage (VDC)	Coil Resistance (Ω ± 10%)
3	240	2.4	0.15	13
5	144	4	0.25	35
6	120	4.8	0.3	50
9	80	7.2	0.45	110
12	60	9.6	0.6	200
24	30	19.2	1.2	800
48	15	38.4	2.4	3200

## OUTLINE DIMENSIONS, WIRING DIAGRAM AND LAYOUT

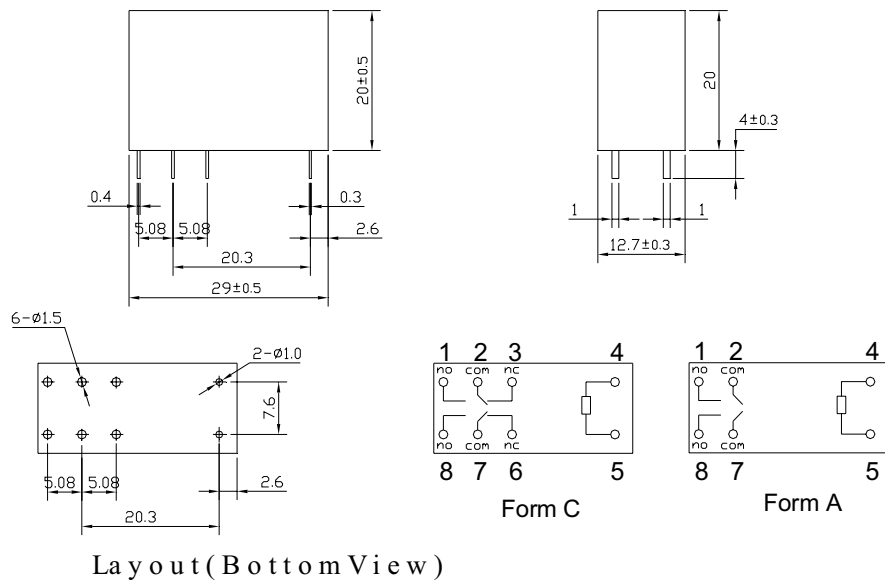

## ENGINEERING DATA

