



a2zelectronic.com

Sourcing Simplified



MITSUBISHI IGBT MODULES  
**CM100DU-12H**  
 HIGH POWER SWITCHING USE  
 INSULATED TYPE

**CM100DU-12H**



- IC ..... 100A
- VCES ..... 600V
- Insulated Type
- 2-elements in a pack

**APPLICATION**

UPS, NC machine, AC-Drive control, Servo, Welders

**OUTLINE DRAWING & CIRCUIT DIAGRAM**

Dimensions in mm

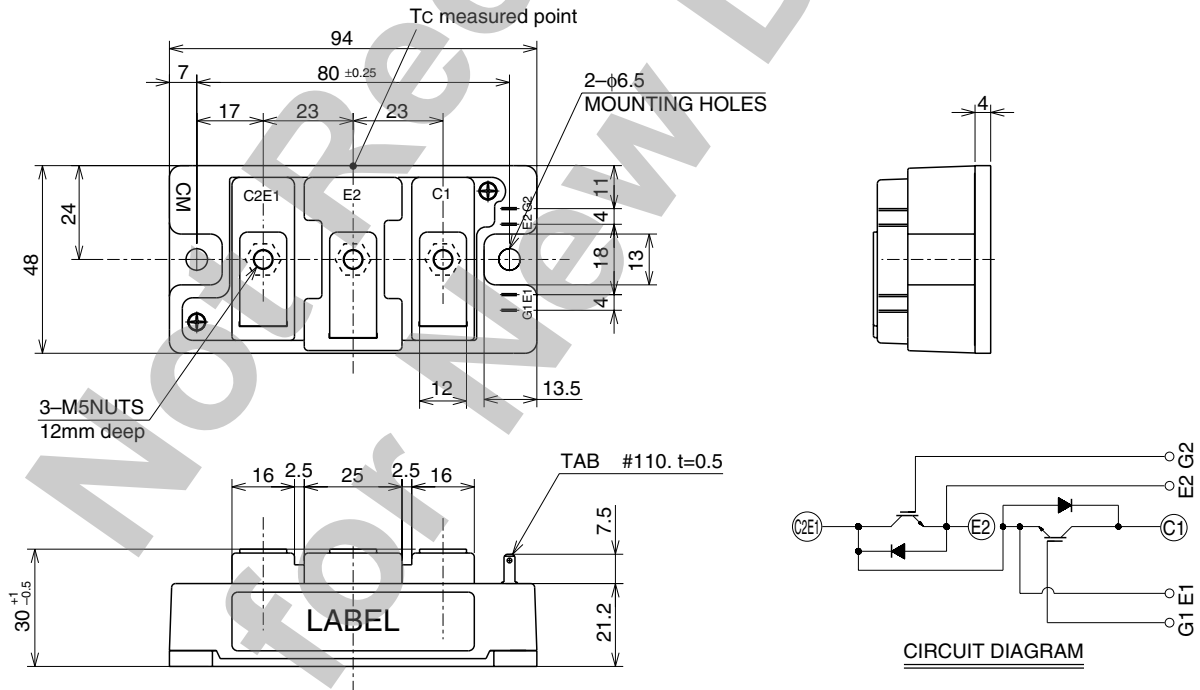

CM100DU-12H

HIGH POWER SWITCHING USE  
INSULATED TYPE

MAXIMUM RATINGS (Tj = 25°C, unless otherwise specified)

Symbol	Item	Conditions	Ratings	Unit
V <sub>CE</sub>	Collector-emitter voltage	V <sub>GE</sub> = 0V	600	V
V <sub>GE</sub>	Gate-emitter voltage	V <sub>CE</sub> = 0V	±20	V
I <sub>C</sub>	Collector current	T <sub>C</sub> = 25°C	100	A
I <sub>CM</sub>		Pulse (Note 1)	200	A
I <sub>E</sub> (Note 2)	Emitter current	T <sub>C</sub> = 25°C	100	A
I <sub>EM</sub> (Note 2)		Pulse (Note 1)	200	A
P <sub>C</sub> (Note 3)	Maximum collector dissipation	T <sub>C</sub> = 25°C	400	W
T <sub>j</sub>	Junction temperature	—	-40 ~ +150	°C
T <sub>stg</sub>	Storage temperature	—	-40 ~ +125	°C
V <sub>iso</sub>	Isolation voltage	Charged part to base plate, f = 60Hz, AC 1 minute	2500	V <sub>rms</sub>
—	Mounting torque	Main terminals M5 screw	2.5 ~ 3.5	N·m
		Mounting M6 screw	3.5 ~ 4.5	N·m
—	Weight	Typical value	310	g

ELECTRICAL CHARACTERISTICS (Tj = 25°C, unless otherwise specified)

Symbol	Item	Test Conditions	Limits			Unit
			Min	Typ	Max	
I <sub>CE</sub>	Collector cutoff current	V <sub>CE</sub> = V <sub>CE</sub> , V <sub>GE</sub> = 0V	—	—	1	mA
V <sub>GE(th)</sub>	Gate-emitter threshold voltage	I <sub>C</sub> = 10mA, V <sub>CE</sub> = 10V	4.5	6	7.5	V
I <sub>GES</sub>	Gate-leakage current	±V <sub>GE</sub> = V <sub>GES</sub> , V <sub>CE</sub> = 0V	—	—	0.5	µA
V <sub>CE(sat)</sub>	Collector-emitter saturation voltage	I <sub>C</sub> = 100A, V <sub>GE</sub> = 15V (Note 4)	—	2.4	3.0	V
		T <sub>j</sub> = 125°C	—	2.6	—	
C <sub>ies</sub>	Input capacitance	V <sub>CE</sub> = 10V	—	—	8.8	nF
C <sub>oes</sub>	Output capacitance	V <sub>GE</sub> = 0V	—	—	4.8	nF
C <sub>res</sub>	Reverse transfer capacitance		—	—	1.3	nF
Q <sub>G</sub>	Total gate charge	V <sub>CC</sub> = 300V, I <sub>C</sub> = 100A, V <sub>GE</sub> = 15V	—	200	—	nC
t <sub>d(on)</sub>	Turn-on delay time	V <sub>CC</sub> = 300V, I <sub>C</sub> = 100A	—	—	100	ns
t <sub>r</sub>	Turn-on rise time	V <sub>GE</sub> = ±15V	—	—	250	ns
t <sub>d(off)</sub>	Turn-off delay time	R <sub>G</sub> = 6.3Ω	—	—	200	ns
t <sub>f</sub>	Turn-off fall time	Resistive load	—	—	300	ns
V <sub>EC</sub> (Note 2)	Emitter-collector voltage	I <sub>E</sub> = 100A, V <sub>GE</sub> = 0V	—	—	2.6	V
t <sub>rr</sub> (Note 2)	Reverse recovery time	I <sub>E</sub> = 100A,	—	—	160	ns
Q <sub>rr</sub> (Note 2)	Reverse recovery charge	die / dt = -200A / µs	—	0.24	—	µC
R <sub>th(j-c)Q</sub>	Thermal resistance (Note 5)	Junction to case, IGBT part (Per 1/2 module)	—	—	0.31	K/W
R <sub>th(j-c)R</sub>		Junction to case, FWDi part (Per 1/2 module)	—	—	0.7	K/W
R <sub>th(c-f)</sub>	Contact thermal resistance	Case to heat sink, conductive grease applied (Per 1/2 module) (Note 6)	—	0.07	—	K/W

Note 1. Pulse width and repetition rate should be such that the device junction temperature (T<sub>j</sub>) does not exceed T<sub>jmax</sub> rating.

2. I<sub>E</sub>, V<sub>EC</sub>, t<sub>rr</sub>, Q<sub>rr</sub> & die/dt represent characteristics of the anti-parallel, emitter-collector free-wheel diode.

3. Junction temperature (T<sub>j</sub>) should not increase beyond 150°C.

4. Pulse width and repetition rate should be such as to cause negligible temperature rise.

5. Case temperature (T<sub>C</sub>) measured point is shown in page OUTLINE DRAWING.

6. Typical value is measured by using thermally conductive grease of λ = 0.9[W/(m · K)].

# CM100DU-12H

HIGH POWER SWITCHING USE  
INSULATED TYPE

PERFORMANCE CURVES

OUTPUT CHARACTERISTICS  
(TYPICAL)

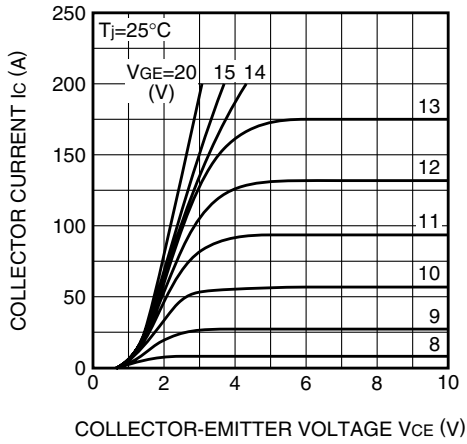

TRANSFER CHARACTERISTICS  
(TYPICAL)

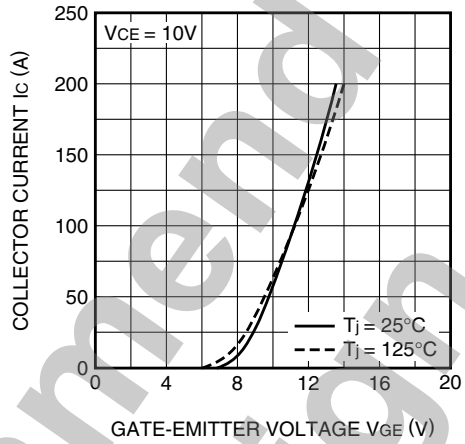

COLLECTOR-EMITTER SATURATION  
VOLTAGE CHARACTERISTICS  
(TYPICAL)

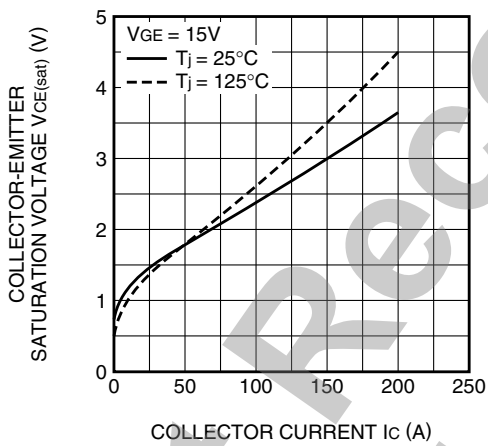

COLLECTOR-EMITTER SATURATION  
VOLTAGE CHARACTERISTICS  
(TYPICAL)

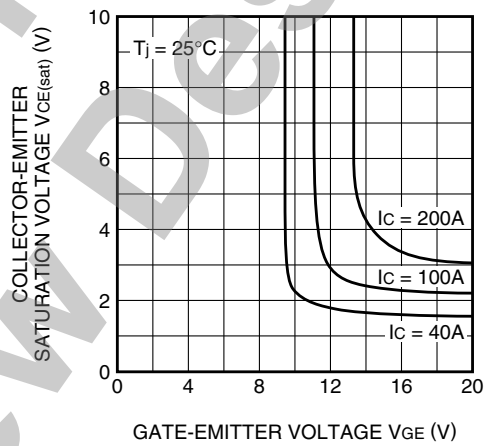

FREE-WHEEL DIODE  
FORWARD CHARACTERISTICS  
(TYPICAL)

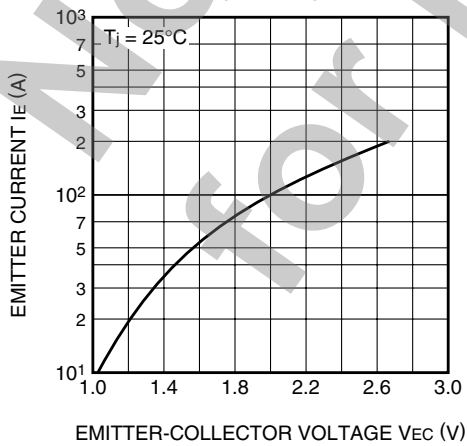

CAPACITANCE CHARACTERISTICS  
(TYPICAL)

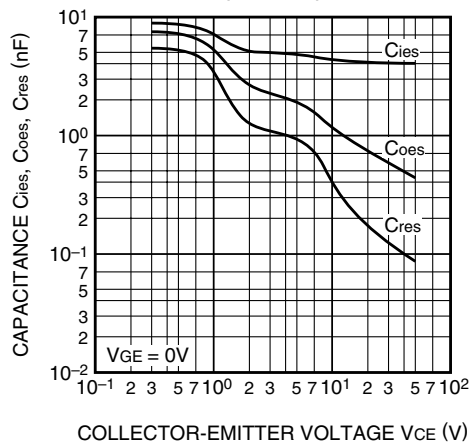

CM100DU-12H

HIGH POWER SWITCHING USE  
INSULATED TYPE

HALF-BRIDGE  
SWITCHING TIME CHARACTERISTICS  
(TYPICAL)

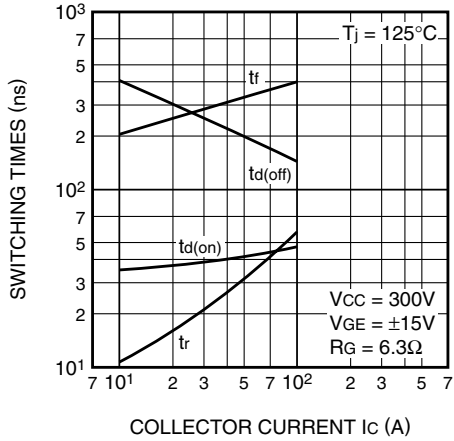

REVERSE RECOVERY CHARACTERISTICS  
OF FREE-WHEEL DIODE  
(TYPICAL)

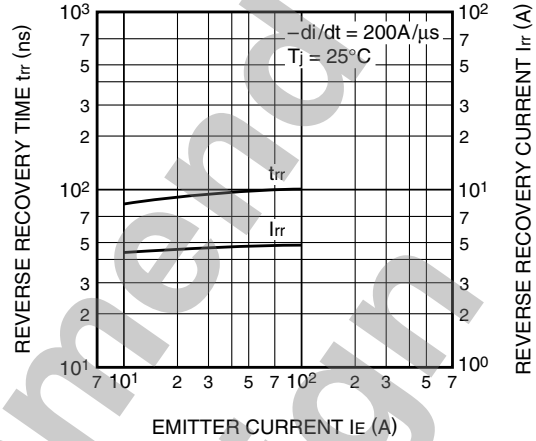

TRANSIENT THERMAL  
IMPEDANCE CHARACTERISTICS  
(IGBT part)

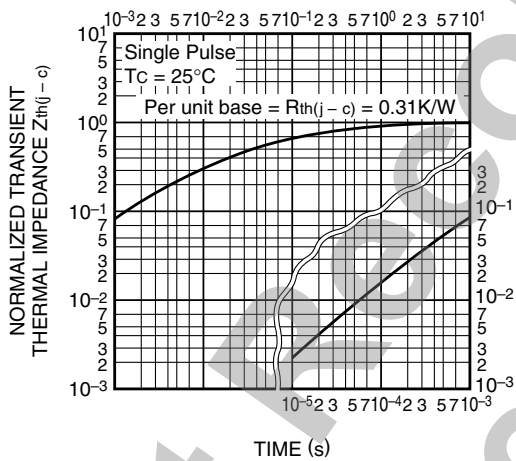

TRANSIENT THERMAL  
IMPEDANCE CHARACTERISTICS  
(FWDi part)

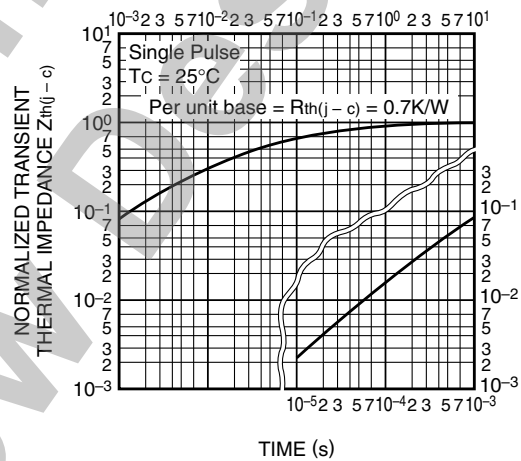

GATE CHARGE CHARACTERISTICS  
(TYPICAL)

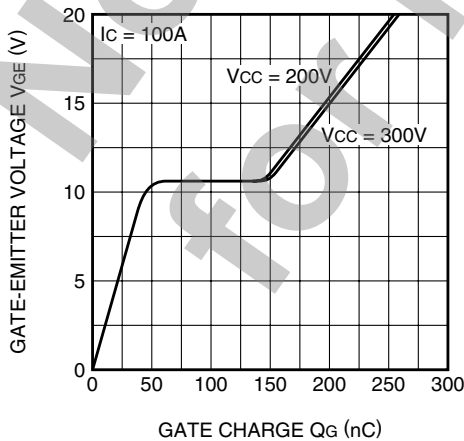



a2zelectronic.com

Sourcing Simplified

